

Documentation Draft

Start: Thu 8/28/14 ID: 3

Finish: Wed 9/10/14 Dur: 14 days

Res:

Revision

Start: Thu 9/11/14 ID: 4

Finish: Wed 9/17/14 Dur: 7 days

Res:

Research

Start: Fri 9/19/14 ID: 16

Finish: Wed 10/1/14 Dur: 13 days

Res:

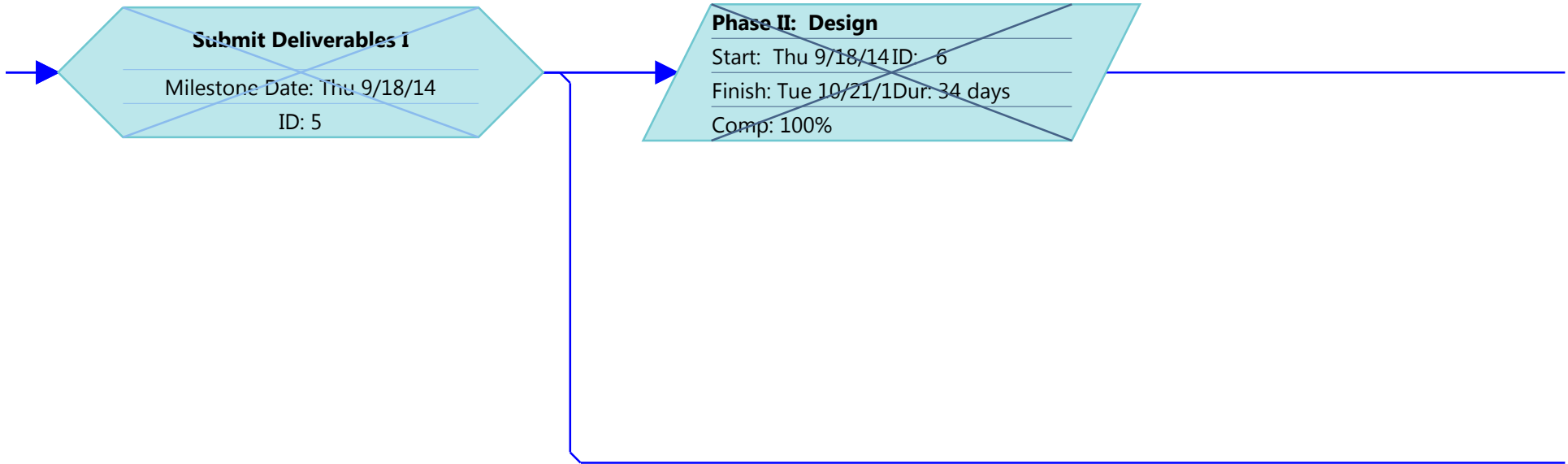

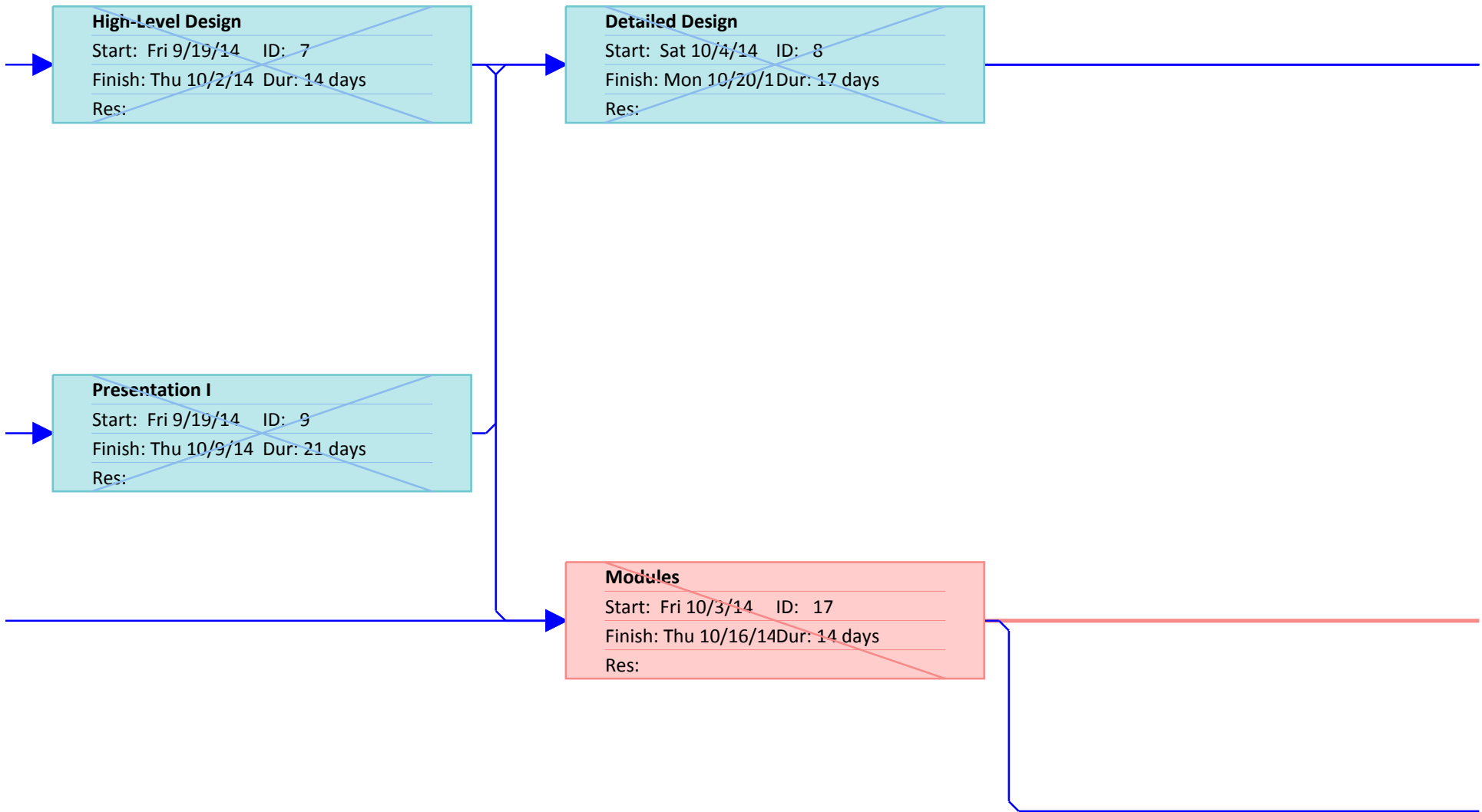

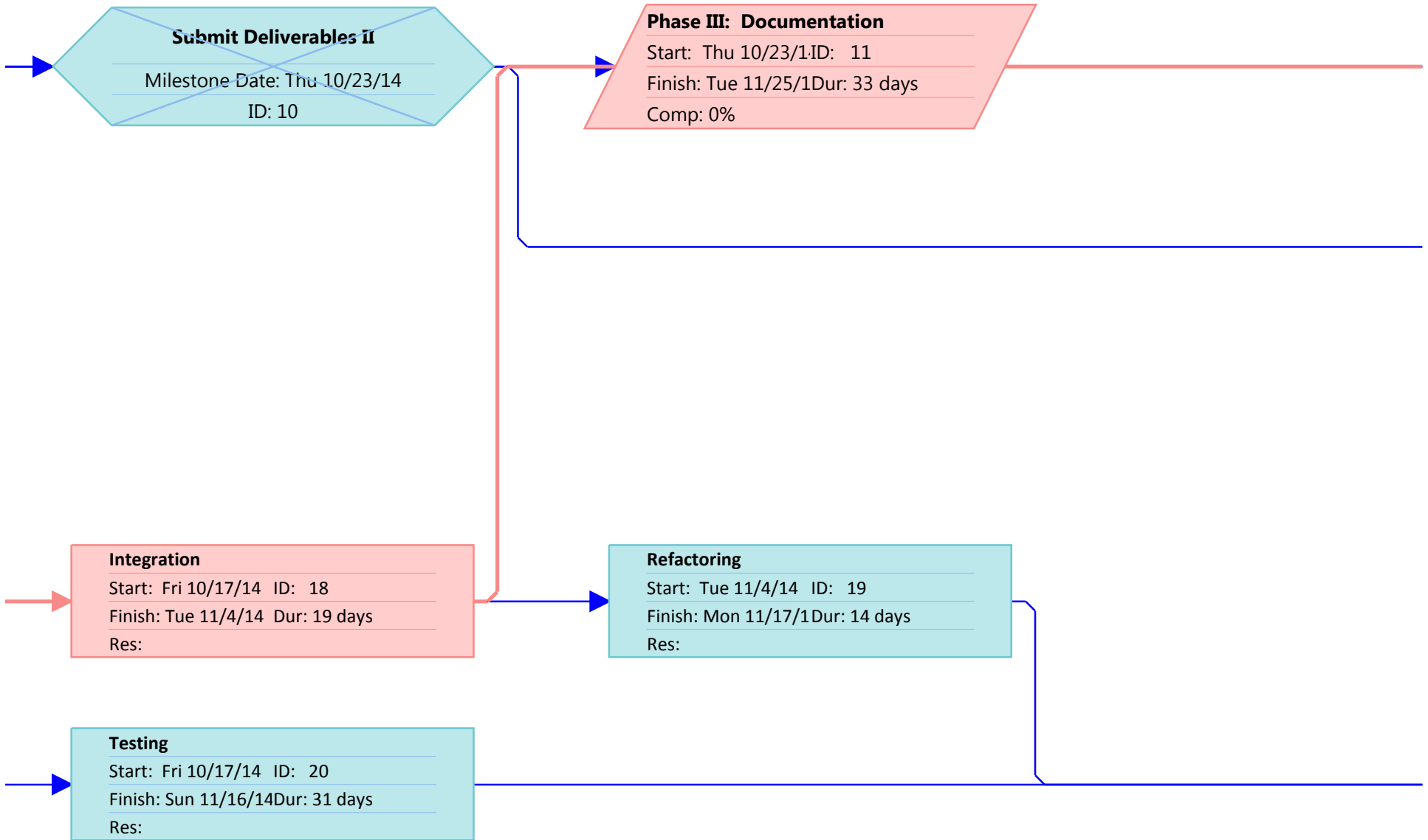

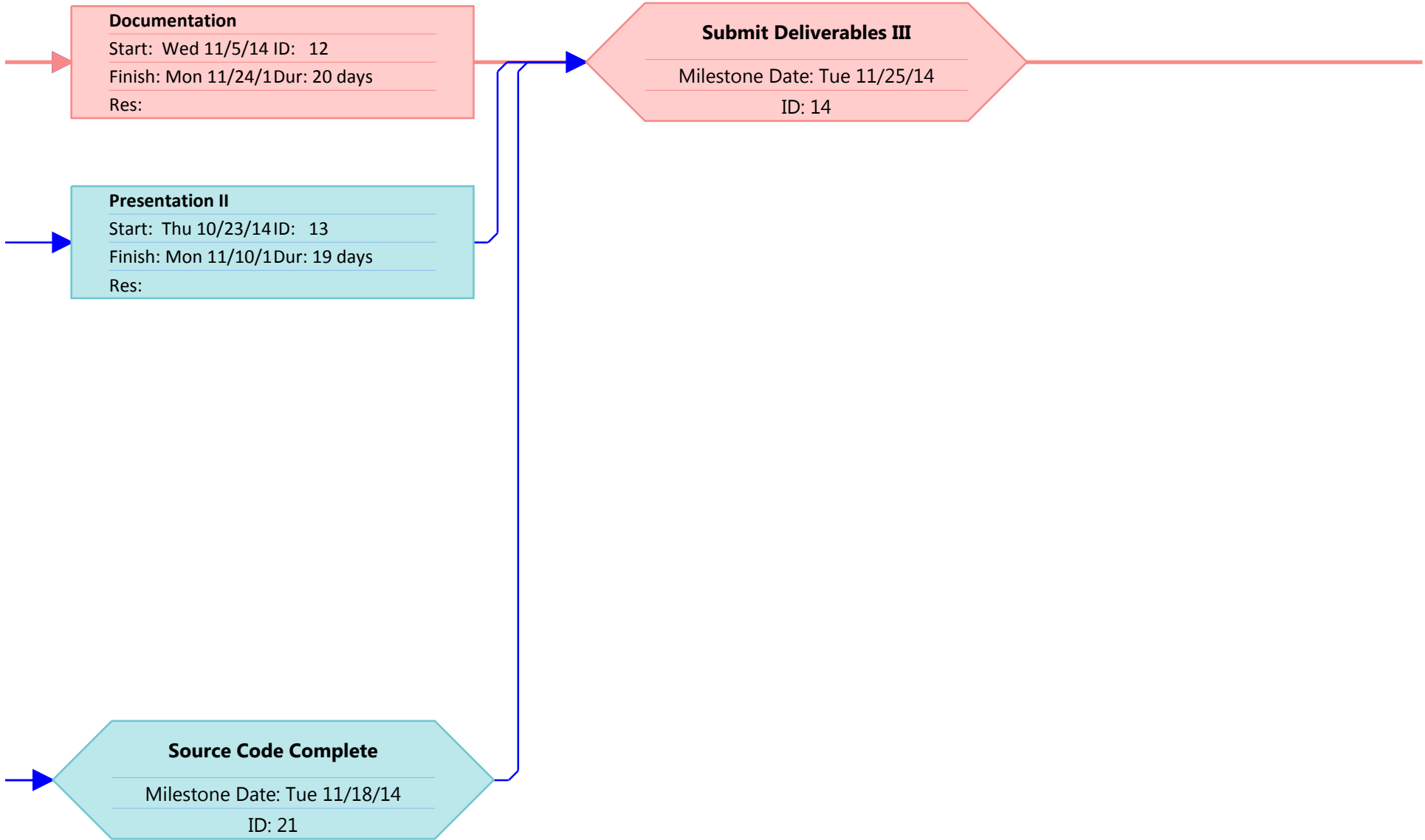

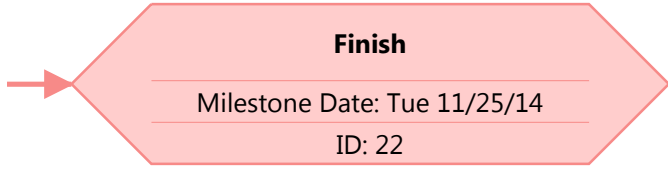







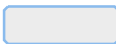

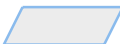
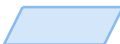



Project: updatePERT
Date: Fri 11/21/14

Critical		Summary		Critical External	
Noncritical		Critical Inserted		External	
Critical Milestone		Inserted		Project Summary	
Milestone		Critical Marked		Highlighted Critical	
Critical Summary		Marked		Highlighted Noncritical	